

# F-9000SS WATERFREE URINAL WALL PANEL INSTALLATION INSTRUCTIONS

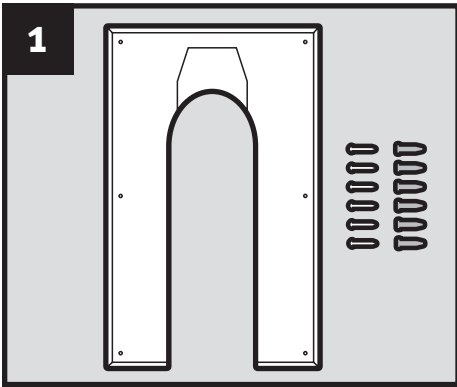

1 Verify contents of kit: Wall panel (qty 1), security screws (qty 6), plastic anchors (qty 6).

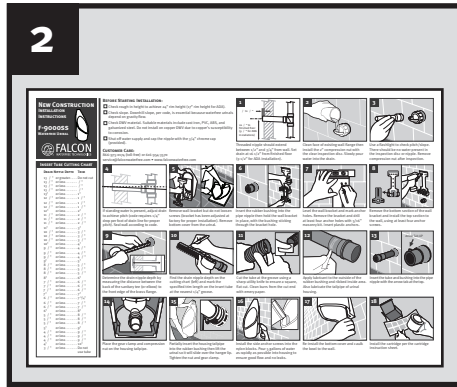

2 Using installation instructions for the urinal, follow steps 1-15 except DO NOT tighten nut and gear clamp.

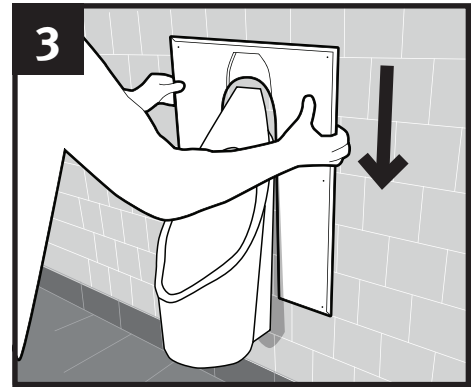

3 Pull urinal back sufficiently to slide the wall panel in position on wall.

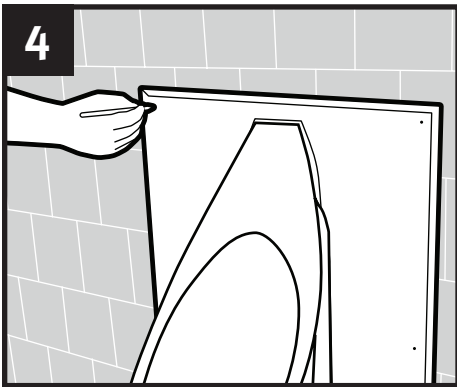

4 Push urinal back into position to ensure proper positioning of wall panel. Then mark all six holes.

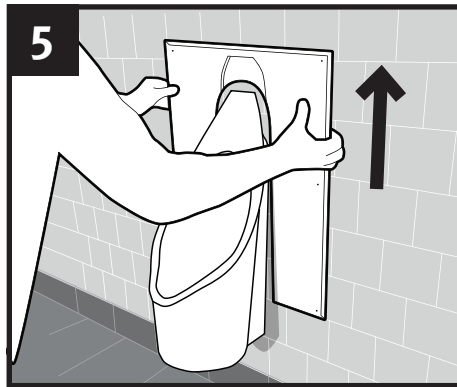

5 Pull urinal back sufficiently to remove wall panel.

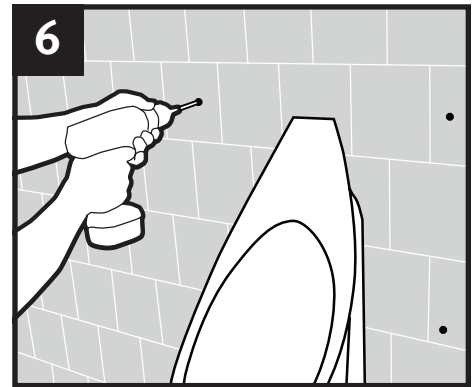

6 Drill six 5/16" holes and install plastic anchors.

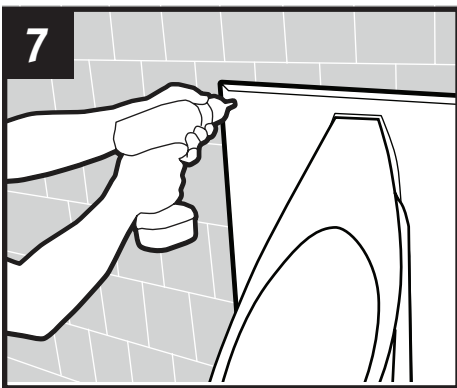

7 Re-install wall panel and return urinal into proper position then install security screws (#2 square head driver bit provided with urinal hardware).

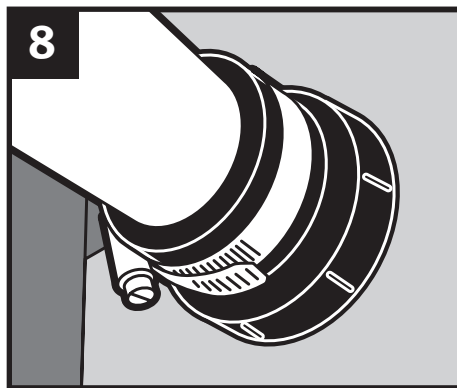

8 Tighten gear clamp.

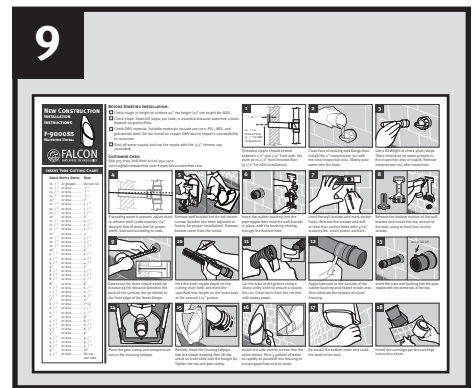

9 Complete installation by following steps 16-18 on the urinal installation instructions.

**CUSTOMER CARE:** 866-975-0174 (toll-free) or 616-954-3570 • [service@falconwaterfree.com](mailto:service@falconwaterfree.com) • [www.falconwaterfree.com](http://www.falconwaterfree.com)

# F-9000SS WATERFREE URINAL

## INSTRUCCIONES DE INSTALACIÓN DEL PANEL PROTECTOR

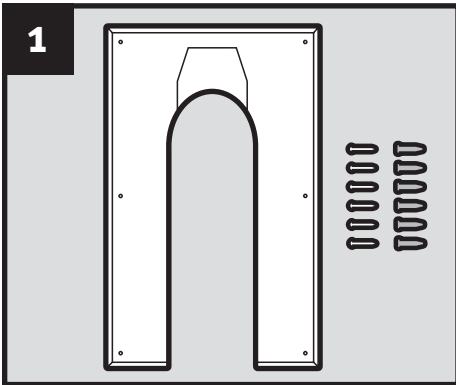

1 Verifique el contenido de kit : Panel Protector (qty 1), tornillos de seguridad (qty 6), tacos de plástico (qty 6).

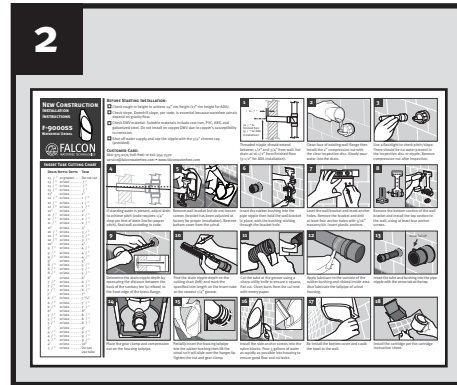

2 Siguiendo las instrucciones de montaje del urinario, siga los pasos 1-15 excepto NO apriete las tuercas, ni la abrazadera.

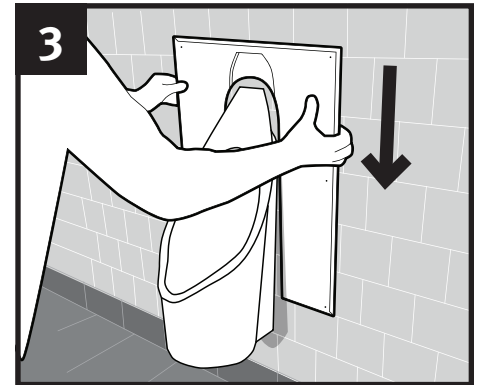

3 Separe de la pared el urinario lo suficiente como para deslizar el panel en la posición adecuada.

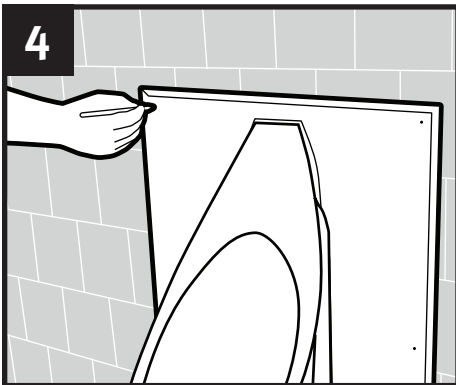

4 Recolecte el urinario a su posición para asegurar una buena posición del panel protector. Marque los seis agujeros.

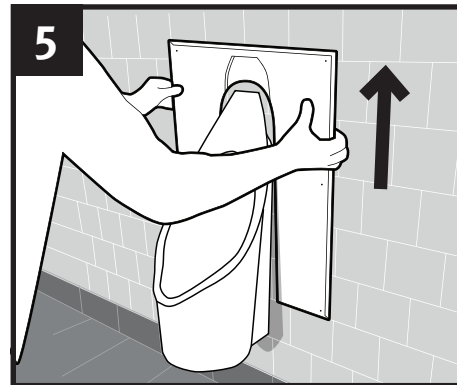

5 Separe el urinario lo suficiente para poder sacar el panel protector.

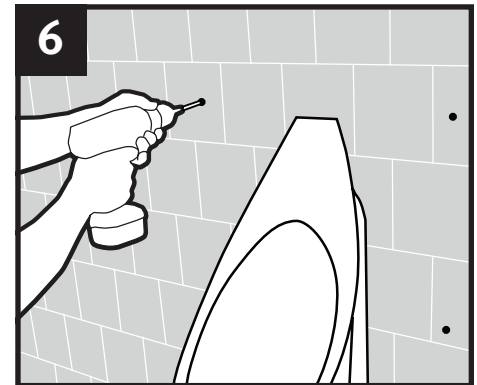

6 Haga seis agujeros 5/16" e instale los tacos de plástico.

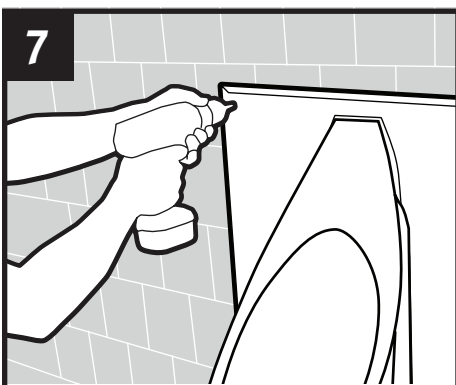

7 Reinstale el panel protector y vuelva a colocar el urinario en posición correcta, monte los tornillos de seguridad (#2 la herramienta adecuada esta incluida en los accesorios del urinario).

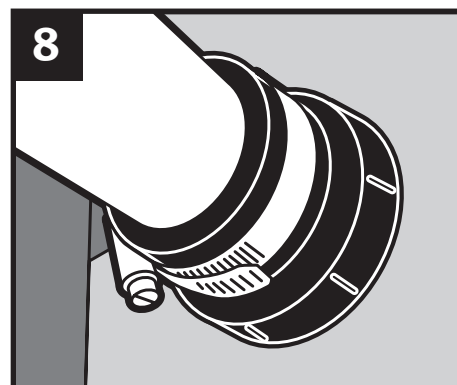

8 Apriete la abrazadera.

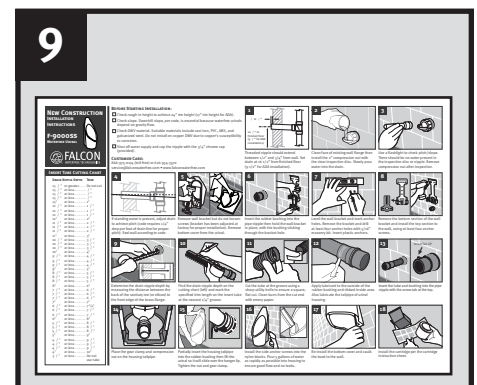

9 Complete la instalación siguiendo los pasos 16-18 de las instrucciones de montaje del urinario.

**ATENCIÓN AL CLIENTE:** 866-975-0174 (llamada gratuita) o 616-954-3570 • [service@falconwaterfree.com](mailto:service@falconwaterfree.com) • [www.falconwaterfree.com](http://www.falconwaterfree.com)